

FEATURES

- Specified over temperature
- Low power consumption (12 μ A)
- Precision monitoring of 2.5 V, 3 V, 3.3 V, and 5 V power supply voltages
- Reset timeout period of 140 ms (minimum)
- Manual reset input
- Output stages
 - Push-pull $\overline{\text{RESET}}$ output (ADM6711)
 - Open-drain $\overline{\text{RESET}}$ output (ADM6713)
- Reset assertion down to 1 V V_{CC}
- Power supply glitch immunity
- 4-lead SC70 package

APPLICATIONS

- Microprocessor systems
- Computers
- Controllers
- Intelligent instruments
- Automotive systems

GENERAL DESCRIPTION

The ADM6711/ADM6713 are reset generator circuits suitable for use in microprocessor-based systems. They provide a reset signal on power-up, power-down, and whenever the supply voltage falls below a preset threshold. In addition, both parts have a debounced manual reset input so that a reset signal can also be initiated with an external switch or logic signal.

With six different reset threshold options available ranging from 2.32 V to 4.63 V, the ADM6711/ADM6713 are suitable for monitoring 2.5 V, 3 V, 3.3 V, and 5 V supplies. A reset timeout of at least 140 ms occurs when V_{CC} rises above the threshold. This gives the supply voltage time to stabilize before the microprocessor starts up.

The ADM6711 has a push-pull output, so no additional external components are needed. The ADM6713 open-drain output requires an external pull-up resistor that can be connected to a voltage higher than V_{CC} , if desired.

FUNCTIONAL BLOCK DIAGRAMS

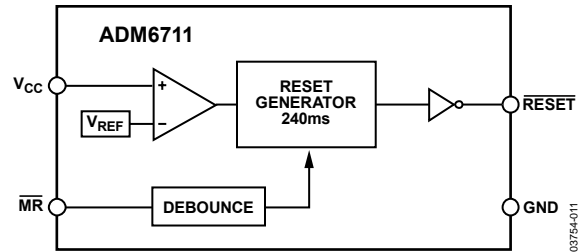

Figure 1.

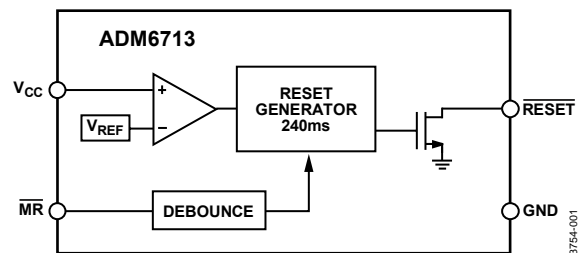

Figure 2.

The parts are highly reliable with accurate voltage references and immunity to fast, negative-going transients on V_{CC} . Low current consumption and space-efficient, 4-lead SC70 packaging make the ADM6711/ADM6713 ideal for use in low power portable applications.

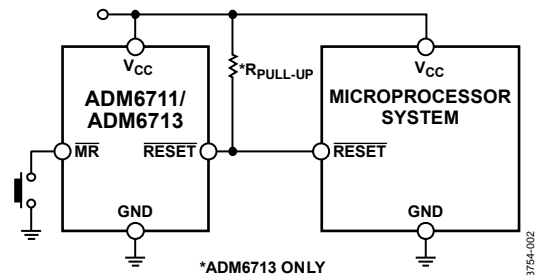

Figure 3. Typical Operating Circuit

Rev. A

Information furnished by Analog Devices is believed to be accurate and reliable. However, no responsibility is assumed by Analog Devices for its use, nor for any infringements of patents or other rights of third parties that may result from its use. Specifications subject to change without notice. No license is granted by implication or otherwise under any patent or patent rights of Analog Devices. Trademarks and registered trademarks are the property of their respective owners.

TABLE OF CONTENTS

| | | | |
|---------------------------------------------------|---|---------------------------------------------------------------------------------------|---|
| Features | 1 | Typical Performance Characteristics | 7 |
| Applications | 1 | Circuit Description | 8 |
| Functional Block Diagrams | 1 | Manual Reset Input | 8 |
| General Description | 1 | Power Supply Glitch Immunity | 8 |
| Revision History | 2 | ADM6713 $\overline{\text{RESET}}$ Output Logic Levels | 8 |
| Specifications | 3 | Ensuring a Valid $\overline{\text{RESET}}$ Output Down To $V_{CC} = 0\text{ V}$ | 8 |
| Absolute Maximum Ratings | 5 | Outline Dimensions | 9 |
| ESD Caution | 5 | Ordering Guide | 9 |
| Pin Configuration and Function Descriptions | 6 | | |

REVISION HISTORY

12/06—Rev. 0 to Rev. A

| | |
|---------------------------------------|-----------|
| Updated Format | Universal |
| Changes to Specifications Table | 3 |
| Changes to Figure 10 | 8 |
| Changes to Ordering Guide | 9 |

8/03—Revision 0: Initial Version

SPECIFICATIONS

V_{CC} = full operating range; $T_A = T_{MIN}$ to T_{MAX} ; V_{CC} typ = 5 V for L/M models, 3.3 V for T/S models, 3 V for R models, and 2.5 V for Z models, unless otherwise noted.

Table 1.

| Parameter | Min | Typ | Max | Unit | Test Conditions/Comments |
|-----------------------------------------|--------------|------|------|-----------------------|---------------------------------------------------------------------------------------|
| SUPPLY | | | | | |
| V_{CC} Operating Voltage Range | 1.0 | | 5.5 | V | $T_A = 0^\circ\text{C}$ to 70°C |
| | 1.2 | | 5.5 | V | $T_A = -40^\circ\text{C}$ to $+125^\circ\text{C}$ |
| Supply Current | | 16 | 35 | μA | $V_{CC} < 5.5$ V, ADM671_L/M, $T_A = -40^\circ\text{C}$ to $+85^\circ\text{C}$ |
| | | 12 | 30 | μA | $V_{CC} < 3.6$ V, ADM671_R/S/T/Z, $T_A = -40^\circ\text{C}$ to $+85^\circ\text{C}$ |
| | | | 60 | μA | $V_{CC} < 5.5$ V, ADM671_L/M, $T_A = 85^\circ\text{C}$ to 125°C |
| | | | 60 | μA | $V_{CC} < 3.6$ V, ADM671_R/S/T/Z, $T_A = 85^\circ\text{C}$ to 125°C |
| RESET VOLTAGE THRESHOLD | | | | | |
| ADM671_L | 4.56 | 4.63 | 4.70 | V | $T_A = 25^\circ\text{C}$ |
| | 4.50 | | 4.75 | V | $T_A = -40^\circ\text{C}$ to $+85^\circ\text{C}$ |
| | 4.44 | | 4.82 | V | $T_A = 85^\circ\text{C}$ to 125°C |
| ADM671_M | 4.31 | 4.38 | 4.45 | V | $T_A = 25^\circ\text{C}$ |
| | 4.25 | | 4.50 | V | $T_A = -40^\circ\text{C}$ to $+85^\circ\text{C}$ |
| | 4.20 | | 4.56 | V | $T_A = 85^\circ\text{C}$ to 125°C |
| ADM671_T | 3.04 | 3.08 | 3.11 | V | $T_A = 25^\circ\text{C}$ |
| | 3.00 | | 3.15 | V | $T_A = -40^\circ\text{C}$ to $+85^\circ\text{C}$ |
| | 2.95 | | 3.21 | V | $T_A = 85^\circ\text{C}$ to 125°C |
| ADM671_S | 2.89 | 2.93 | 2.96 | V | $T_A = 25^\circ\text{C}$ |
| | 2.85 | | 3.00 | V | $T_A = -40^\circ\text{C}$ to $+85^\circ\text{C}$ |
| | 2.81 | | 3.05 | V | $T_A = 85^\circ\text{C}$ to 125°C |
| ADM671_R | 2.59 | 2.63 | 2.66 | V | $T_A = 25^\circ\text{C}$ |
| | 2.55 | | 2.70 | V | $T_A = -40^\circ\text{C}$ to $+85^\circ\text{C}$ |
| | 2.52 | | 2.74 | V | $T_A = 85^\circ\text{C}$ to 125°C |
| ADM671_Z | 2.28 | 2.32 | 2.35 | V | $T_A = 25^\circ\text{C}$ |
| | 2.25 | | 2.38 | V | $T_A = -40^\circ\text{C}$ to $+85^\circ\text{C}$ |
| | 2.22 | | 2.42 | V | $T_A = 85^\circ\text{C}$ to 125°C |
| RESET THRESHOLD TEMPERATURE COEFFICIENT | | 30 | | ppm/ $^\circ\text{C}$ | |
| V_{CC} to RESET DELAY | | 20 | | μs | $V_{CC} = V_{TH}$ to $(V_{TH} - 100$ mV) |
| RESET ACTIVE TIMEOUT PERIOD | 140 | 240 | 460 | ms | $T_A = -40^\circ\text{C}$ to $+85^\circ\text{C}$ |
| | 100 | | 640 | ms | $T_A = 85^\circ\text{C}$ to 125°C |
| RESET OUTPUT VOLTAGE | | | | | |
| Low (ADM6711/ADM6713) | | | 0.3 | V | $V_{CC} = V_{TH}$ min, $I_{SINK} = 1.2$ mA, ADM671_R/S/T/Z |
| | | | 0.4 | V | $V_{CC} = V_{TH}$ min, $I_{SINK} = 3.2$ mA, ADM671_L/M |
| High (ADM6711) | $0.8 V_{CC}$ | | 0.3 | V | $V_{CC} > 1.0$ V, $I_{SINK} = 50$ μA |
| | $0.8 V_{CC}$ | | | V | $V_{CC} > V_{TH}$ max, $I_{SOURCE} = 500$ μA , ADM6711R/S/T/Z |
| | | | | V | $V_{CC} > V_{TH}$ max, $I_{SOURCE} = 800$ μA , ADM6711L/M |

ADM6711/ADM6713

| Parameter | Min | Typ | Max | Unit | Test Conditions/Comments |
|--------------------------------------------|--------------|-----|--------------|------------------|--------------------------------------|
| RESET OPEN-DRAIN OUTPUT LEAKAGE CURRENT | | | 1 | μA | $V_{CC} > V_{TH}$, RESET deasserted |
| MANUAL RESET (MR) | | | | | |
| Input Threshold | $0.3 V_{CC}$ | | $0.7 V_{CC}$ | V | V_{IL} |
| | | | | V | V_{IH} |
| Pull-Up Resistance | 10 | 20 | | $\text{k}\Omega$ | |
| Minimum Pulse width | 1 | | | μs | |
| Glitch Immunity | | 100 | | ns | |
| Reset Delay | | 200 | | ns | |

ABSOLUTE MAXIMUM RATINGS

$T_A = 25^\circ\text{C}$, unless otherwise noted.

Table 2.

| Parameter | Rating |
|----------------------------------------------------|-------------------------------|
| V_{CC} | -0.3 V to +6 V |
| $\overline{\text{RESET}}$ (Push-Pull) | -0.3 V to ($V_{CC} + 0.3$ V) |
| $\overline{\text{RESET}}$ (Open-Drain) | -0.3 V to +6 V |
| $\overline{\text{MR}}$ | -0.3 V to ($V_{CC} + 0.3$ V) |
| Input Current V_{CC} , $\overline{\text{MR}}$ | 20 mA |
| Output Current $\overline{\text{RESET}}$ | 20 mA |
| Rate of Rise, V_{CC} | 100 V/ μs |
| θ_{JA} Thermal Impedance, SC70 | 146°C/W |
| Operating Temperature Range | -40°C to +125°C |
| Storage Temperature Range | -65°C to +150°C |
| Lead Temperature (Soldering, 10 sec) | 300°C |

Stresses above those listed under Absolute Maximum Ratings may cause permanent damage to the device. This is a stress rating only; functional operation of the device at these or any other conditions above those indicated in the operational section of this specification is not implied. Exposure to absolute maximum rating conditions for extended periods may affect device reliability.

Table 3. $\overline{\text{RESET}}$ Threshold Options

| Model | $\overline{\text{RESET}}$ Threshold (V) |
|----------|-----------------------------------------|
| ADM671_L | 4.63 |
| ADM671_M | 4.38 |
| ADM671_T | 3.08 |
| ADM671_S | 2.93 |
| ADM671_R | 2.63 |
| ADM671_Z | 2.32 |

ESD CAUTION



ESD (electrostatic discharge) sensitive device. Charged devices and circuit boards can discharge without detection. Although this product features patented or proprietary protection circuitry, damage may occur on devices subjected to high energy ESD. Therefore, proper ESD precautions should be taken to avoid performance degradation or loss of functionality.

ADM6711/ADM6713

PIN CONFIGURATION AND FUNCTION DESCRIPTIONS

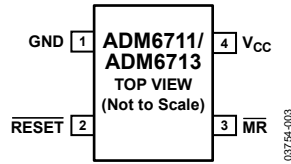

Figure 4. Pin Configuration

Table 4. Pin Function Descriptions

| Pin No. | Mnemonic | Description |
|---------|---------------------------|--------------------------------------------------------------------------------------------------------------------------------------------------------------------------------------------------------------|
| 1 | GND | Ground Reference for All Signals (0 V). |
| 2 | $\overline{\text{RESET}}$ | Active Low Logic Input. $\overline{\text{RESET}}$ remains low while V_{CC} is below the reset threshold and remains low for 240 ms (typical) after V_{CC} rises above the reset threshold. |
| 3 | $\overline{\text{MR}}$ | Manual Reset. This active low debounced input ignores input pulses of 100 ns (typical) and is guaranteed to accept input pulses greater than 1 μs . Leave floating when not used. |
| 4 | V_{CC} | Supply Voltage Being Monitored. |

TYPICAL PERFORMANCE CHARACTERISTICS

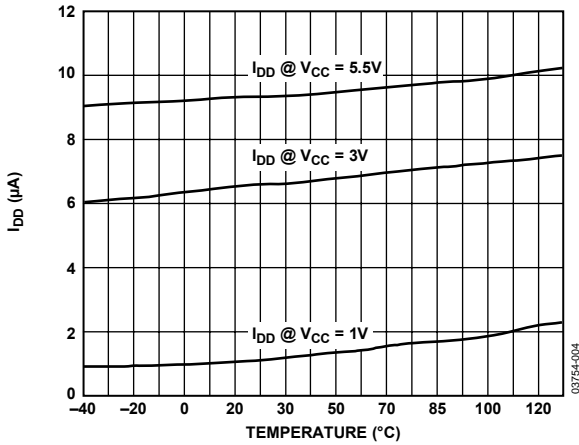

Figure 5. Supply Current vs. Temperature

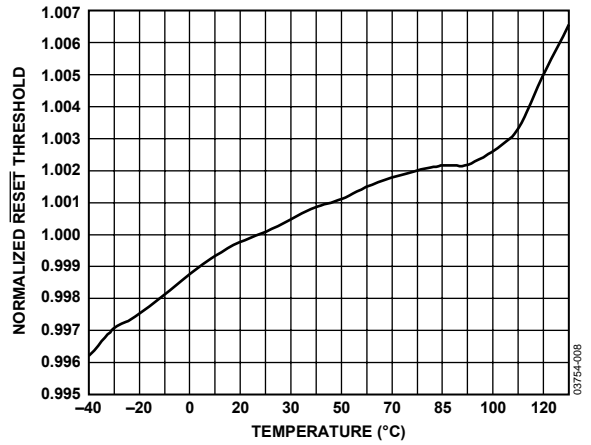

Figure 8. $\overline{\text{RESET}}$ Threshold Deviation vs. Temperature

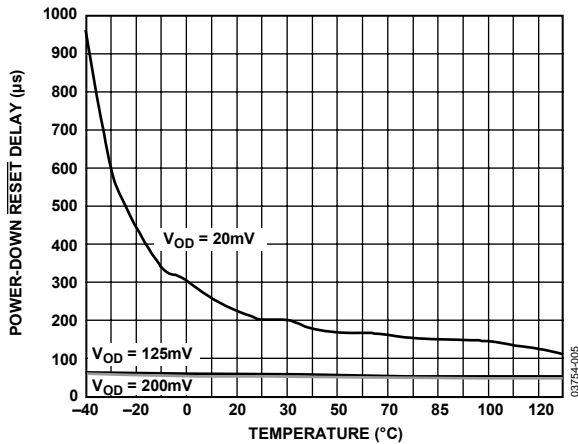

Figure 6. Power-Down $\overline{\text{RESET}}$ Delay vs. Temperature: ADM671_R/S/T/Z

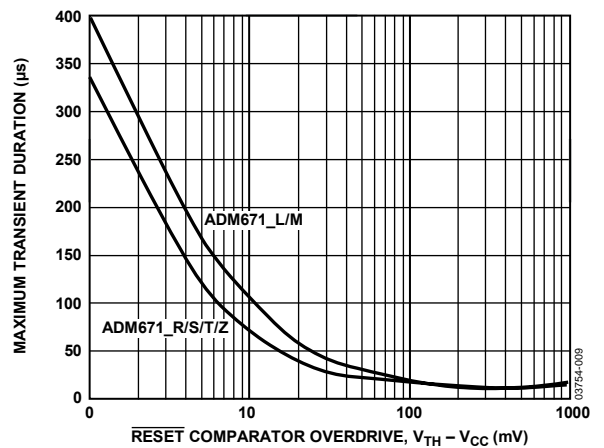

Figure 9. Maximum Transient Duration (Without Causing a $\overline{\text{RESET}}$ Pulse) vs. $\overline{\text{RESET}}$ Comparator Overdrive

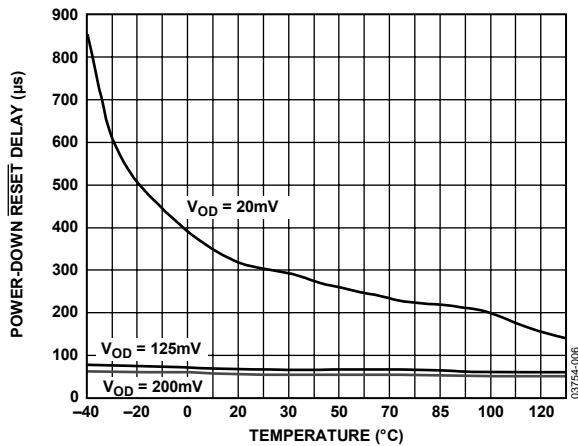

Figure 7. Power-Down $\overline{\text{RESET}}$ Delay vs. Temperature: ADM671_L/M

CIRCUIT DESCRIPTION

The ADM6711/ADM6713 are designed to protect the integrity of a system's operation by ensuring the proper operation of the system during power-up, power-down, and brownout conditions.

When the ADM6711/ADM6713 are powered up, the $\overline{\text{RESET}}$ output remains low for a period equal to the typical reset active timeout period. This is designed to give the system time to power up correctly and for the power supply to stabilize before any devices are brought out of reset and allowed to begin executing instructions. Initializing a system in this way provides a more reliable startup for microprocessor systems.

MANUAL RESET INPUT

The ADM6711/ADM6713 manual reset ($\overline{\text{MR}}$) input allows the system operator to reset a system by means of an external manual switch. Alternatively, a logic signal from another digital circuit can be used to trigger a reset via the $\overline{\text{MR}}$ input.

The $\overline{\text{MR}}$ input ignores negative-going pulses faster than 100 ns (typical) and is guaranteed to accept any negative-going input pulse of a duration greater than or equal to 1 μs . The $\overline{\text{RESET}}$ output remains low while $\overline{\text{MR}}$ is held low and for 240 ms (typical) after $\overline{\text{MR}}$ returns high.

If $\overline{\text{MR}}$ is connected to long cables or is used in a noisy environment, then placing a 0.1 μF capacitor between the $\overline{\text{MR}}$ input and ground helps to remove any fast, negative-going transients.

POWER SUPPLY GLITCH IMMUNITY

The ADM6711/ADM6713 contain internal filtering circuitry that provides immunity to fast transient glitches on the power supply line. Figure 9 illustrates glitch immunity performance by showing the maximum transient duration without causing a reset pulse for glitches with amplitudes in the range of 1 mV to 1000 mV.

Glitch immunity makes the ADM6711/ADM6713 suitable for use in noisy environments. Mounting a 0.1 μF decoupling capacitor as close as possible to the V_{CC} pin improves glitch immunity further.

ADM6713 $\overline{\text{RESET}}$ OUTPUT LOGIC LEVELS

The ADM6713 open-drain $\overline{\text{RESET}}$ output is designed for use with an external pull-up resistor. This resistor can be tied to V_{CC} or any other reasonable voltage level, offering the flexibility to use the ADM6713 to drive a variety of different logic level circuitry.

ENSURING A VALID $\overline{\text{RESET}}$ OUTPUT DOWN TO $V_{\text{CC}} = 0 \text{ V}$

When V_{CC} falls below 0.8 V, the ADM6711/ADM6713 $\overline{\text{RESET}}$ output no longer sinks current, and a high impedance CMOS logic input connected to $\overline{\text{RESET}}$ may drift to undetermined logic levels. To eliminate this problem, a pull-down resistor is connected from $\overline{\text{RESET}}$ to ground. A 100 k Ω resistor is large enough not to load $\overline{\text{RESET}}$ and small enough to pull $\overline{\text{RESET}}$ to ground.

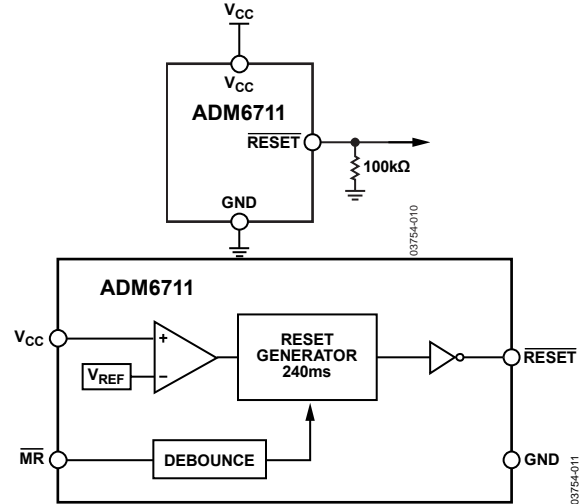
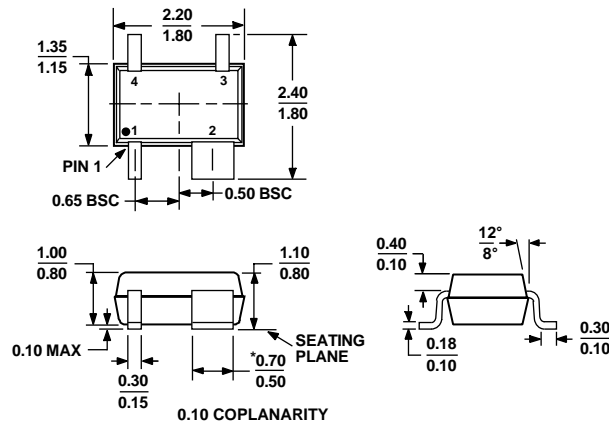

Figure 10. Ensuring a Valid $\overline{\text{RESET}}$ Output Down to $V_{\text{CC}} = 0 \text{ V}$

OUTLINE DIMENSIONS



*PACKAGE OUTLINE CORRESPONDS IN FULL TO EIAJ SC82 EXCEPT FOR WIDTH OF PIN 2 AS SHOWN.

Figure 11. 4-Lead Thin Shrink Small Outline Transistor Package [SC70] (EIAJ SC82 body) (KS-4)

Dimensions shown in millimeters

ORDERING GUIDE

| Model | RESET Threshold (V) | Temperature Range | Package Description | Package Option | Ordering Quantity (k) | Branding |
|----------------------------------|---------------------|-------------------|---------------------|----------------|-----------------------|----------|
| ADM6711LAKS-REEL | 4.63 | -40°C to +125°C | 4-Lead SC70 | KS-4 | 10 | M0B |
| ADM6711LAKSZ-REEL ¹ | 4.63 | -40°C to +125°C | 4-Lead SC70 | KS-4 | 10 | M4U |
| ADM6711LAKS-REEL-7 | 4.63 | -40°C to +125°C | 4-Lead SC70 | KS-4 | 3 | M0B |
| ADM6711LAKSZ-REEL-7 ¹ | 4.63 | -40°C to +125°C | 4-Lead SC70 | KS-4 | 3 | M4U |
| ADM6711MAKS-REEL | 4.38 | -40°C to +125°C | 4-Lead SC70 | KS-4 | 10 | M0C |
| ADM6711MAKS-REEL-7 | 4.38 | -40°C to +125°C | 4-Lead SC70 | KS-4 | 3 | M0C |
| ADM6711MAKSZ-REEL-7 ¹ | 4.38 | -40°C to +125°C | 4-Lead SC70 | KS-4 | 3 | M86 |
| ADM6711TAKS-REEL | 3.08 | -40°C to +125°C | 4-Lead SC70 | KS-4 | 10 | M0D |
| ADM6711TAKSZ-REEL ¹ | 3.08 | -40°C to +125°C | 4-Lead SC70 | KS-4 | 10 | M4A |
| ADM6711TAKS-REEL-7 | 3.08 | -40°C to +125°C | 4-Lead SC70 | KS-4 | 3 | M0D |
| ADM6711TAKSZ-REEL-7 ¹ | 3.08 | -40°C to +125°C | 4-Lead SC70 | KS-4 | 3 | M4A |
| ADM6711SAKS-REEL | 2.93 | -40°C to +125°C | 4-Lead SC70 | KS-4 | 10 | M0E |
| ADM6711SAKSZ-REEL ¹ | 2.93 | -40°C to +125°C | 4-Lead SC70 | KS-4 | 10 | M4B |
| ADM6711SAKS-REEL-7 | 2.93 | -40°C to +125°C | 4-Lead SC70 | KS-4 | 3 | M0E |
| ADM6711SAKSZ-REEL-7 ¹ | 2.93 | -40°C to +125°C | 4-Lead SC70 | KS-4 | 3 | M4B |
| ADM6711RAKS-REEL | 2.63 | -40°C to +125°C | 4-Lead SC70 | KS-4 | 10 | M0F |
| ADM6711RAKSZ-REEL ¹ | 2.63 | -40°C to +125°C | 4-Lead SC70 | KS-4 | 10 | M5F |
| ADM6711RAKS-REEL-7 | 2.63 | -40°C to +125°C | 4-Lead SC70 | KS-4 | 3 | M0F |
| ADM6711RAKSZ-REEL-7 ¹ | 2.63 | -40°C to +125°C | 4-Lead SC70 | KS-4 | 3 | M5F |
| ADM6711ZAKS-REEL | 2.32 | -40°C to +125°C | 4-Lead SC70 | KS-4 | 10 | M0G |
| ADM6711ZAKSZ-REEL ¹ | 2.32 | -40°C to +125°C | 4-Lead SC70 | KS-4 | 10 | M4H |
| ADM6711ZAKS-REEL-7 | 2.32 | -40°C to +125°C | 4-Lead SC70 | KS-4 | 3 | M0G |
| ADM6711ZAKSZ-REEL-7 ¹ | 2.32 | -40°C to +125°C | 4-Lead SC70 | KS-4 | 3 | M4H |
| ADM6713LAKS-REEL | 4.63 | -40°C to +125°C | 4-Lead SC70 | KS-4 | 10 | M0H |
| ADM6713LAKSZ-REEL ¹ | 4.63 | -40°C to +125°C | 4-Lead SC70 | KS-4 | 10 | M87 |
| ADM6713LAKS-REEL-7 | 4.63 | -40°C to +125°C | 4-Lead SC70 | KS-4 | 3 | M0H |
| ADM6713LAKSZ-REEL-7 ¹ | 4.63 | -40°C to +125°C | 4-Lead SC70 | KS-4 | 3 | M87 |
| ADM6713MAKS-REEL | 4.38 | -40°C to +125°C | 4-Lead SC70 | KS-4 | 10 | M0J |
| ADM6713MAKS-REEL-7 | 4.38 | -40°C to +125°C | 4-Lead SC70 | KS-4 | 3 | M0J |
| ADM6713MAKSZ-REEL-7 ¹ | 4.38 | -40°C to +125°C | 4-Lead SC70 | KS-4 | 3 | M88 |
| ADM6713TAKS-REEL | 3.08 | -40°C to +125°C | 4-Lead SC70 | KS-4 | 10 | M0K |

ADM6711/ADM6713

| Model | RESET Threshold (V) | Temperature Range | Package Description | Package Option | Ordering Quantity (k) | Branding |
|----------------------------------|------------------------|----------------------|------------------------|-------------------|--------------------------|----------|
| ADM6713TAKS-REEL-7 | 3.08 | -40°C to +125°C | 4-Lead SC70 | KS-4 | 3 | M0K |
| ADM6713TAKSZ-REEL-7 ¹ | 3.08 | -40°C to +125°C | 4-Lead SC70 | KS-4 | 3 | M89 |
| ADM6713SAKS-REEL | 2.93 | -40°C to +125°C | 4-Lead SC70 | KS-4 | 10 | M0L |
| ADM6713SAKSZ-REEL ¹ | 2.93 | -40°C to +125°C | 4-Lead SC70 | KS-4 | 10 | M57 |
| ADM6713SAKS-REEL-7 | 2.93 | -40°C to +125°C | 4-Lead SC70 | KS-4 | 3 | M0L |
| ADM6713SAKSZ-REEL-7 ¹ | 2.93 | -40°C to +125°C | 4-Lead SC70 | KS-4 | 3 | M57 |
| ADM6713RAKS-REEL | 2.63 | -40°C to +125°C | 4-Lead SC70 | KS-4 | 10 | M0M |
| ADM6713RAKSZ-REEL ¹ | 2.63 | -40°C to +125°C | 4-Lead SC70 | KS-4 | 10 | M4S |
| ADM6713RAKS-REEL-7 | 2.63 | -40°C to +125°C | 4-Lead SC70 | KS-4 | 3 | M0M |
| ADM6713RAKSZ-REEL-7 ¹ | 2.63 | -40°C to +125°C | 4-Lead SC70 | KS-4 | 3 | M4S |
| ADM6713ZAKS-REEL | 2.32 | -40°C to +125°C | 4-Lead SC70 | KS-4 | 10 | M0N |
| ADM6713ZAKSZ-REEL ¹ | 2.32 | -40°C to +125°C | 4-Lead SC70 | KS-4 | 10 | M4R |
| ADM6713ZAKS-REEL-7 | 2.32 | -40°C to +125°C | 4-Lead SC70 | KS-4 | 3 | M0N |
| ADM6713ZAKSZ-REEL-7 ¹ | 2.32 | -40°C to +125°C | 4-Lead SC70 | KS-4 | 3 | M4R |

¹ Z = Pb-free part.

NOTES

NOTES